

ERACLE 8

43CPC008EN

**CONVENTIONAL FIRE ALARM
CONTROL PANEL WITH 8 ZONES**

**INSTALLATION AND
OPERATION MANUAL**

CE1293



Comelit®
Passion. Technology. Design.

CONTENTS

Guarantee.....	3
1. Using the ERACLE 8 controls	4
1.1 ERACLE 8 Operation Modes	5
1.2 LED Indication for the Status of the Zones (1-8).....	5
1.3 LED Indication for the Technical Faults in the System	5
1.4 LED Indication for the System Status	6
1.5 Buttons for Programming and Operation	6
1.6 Switch for Changing the Access Levels	6
2. Installing the ERACLE 8 Panel	7
3. Initial Power-up of ERACLE 8 Panel	8
4. Connecting the Zone Circuits	8
5. Connecting the Sounders Circuits	9
6. Connecting FAULT and FIRE Relay Circuits	9
7. Class Change Function	10
8. Connecting of Repeater Panel	10
9. Programming Master Panel Mode.....	10
10. Programming Repeater Panel Mode.....	10
11. Programming Single Panel Mode.....	10
12. Sounder Delay Mode	11
13. Double Action Mode	11
14. Instant Action Mode	11
15. Operating Instructions	13
15.1 Sound Signalization	13
15.2 Service Modes	13
16. Connection Diagram	16
17. Technical Specifications	17
FIRE ALARM RECORD	18
SERVICE RECORD	18
FIRE ALARM EVENT LOG	19
SPARE PARTS KIT	19



DoP No: 008

Comelit Group S.p.A. Via Don Arrigoni 5 - 24020 Rovetta S. Lorenzo BG Italy

EN 54-2:1997; EN 54-2:1997/AC:1999; EN 54-2:1997/A1:2006;
EN 54-4:1997; EN 54-4:1997/AC:1999; EN 54-4:1997/A1:2002; EN 54-4:1997/A2:2006

ERACLE 8

Intended for use in fire detection and fire alarm systems in and around buildings.

Essential Characteristics	Performance
Performance under fire conditions	Pass
Response delay (response time to fire)	Pass
Operational reliability	Pass
Durability of operational reliability and response delay: temperature resistance	Pass
Durability of operational reliability: humidity resistance	Pass
Durability of operational reliability: vibration resistance	Pass
Durability of operational reliability: electrical resistance	Pass



**This manual contains information on limitations regarding product use and function and information on the limitations as to liability of the manufacturer.
The entire manual should be carefully read!**

WARNING

The system has to be installed by a qualified person to the latest Fire Alarm and Installation Regulations which are mandatory in the applicable country of installation.

Before commencing the installation of this Fire Alarm Panel, ensure it is sited in a position, which is visible to the Fire Brigade when entering the premises, and where ease of access is provided for users and service engineers. Space must be available to easily open external and internal doors.

The Electrical Supply to the panel must be isolated and must not be capable of being accidentally switched off. A 'Lockable Switch fuse Unit' positioned within 2 meters of the panel should be clearly labelled FIRE ALARM - DO NOT SWITCH OFF.

All specifications are subject to change without notice.

1. Using the ERACLE 8 Controls

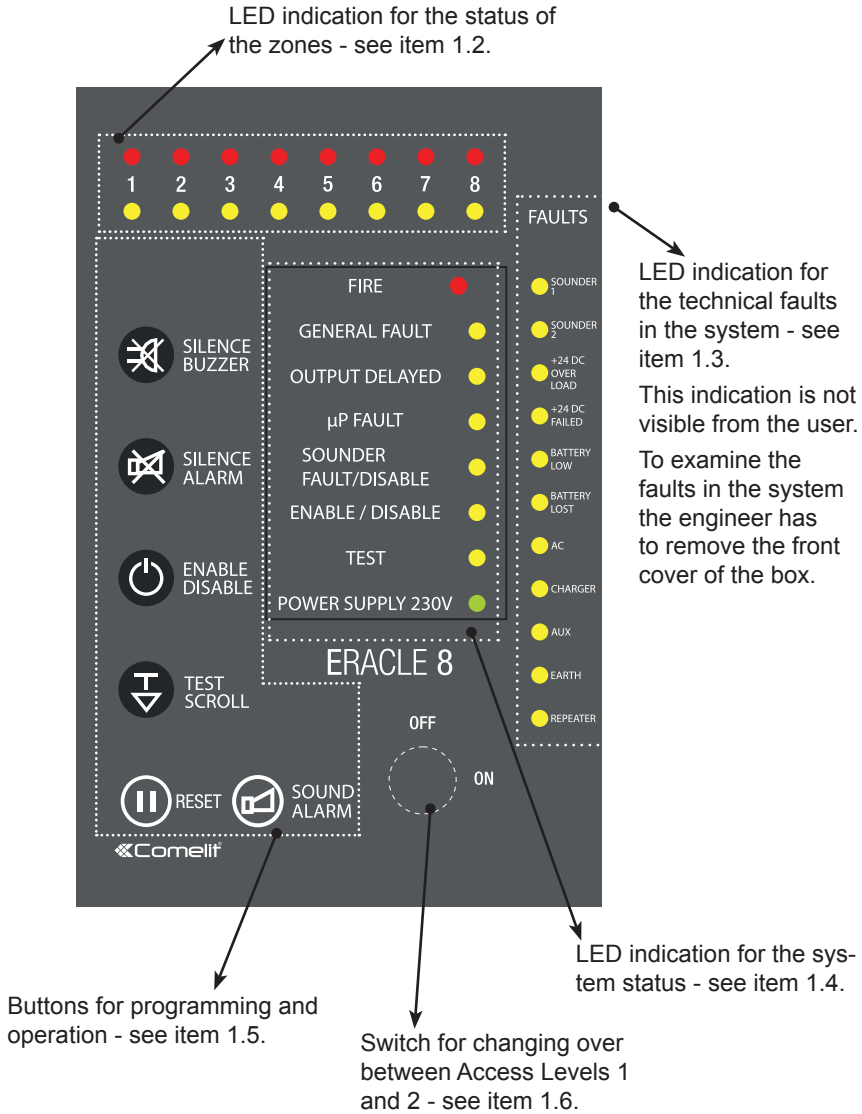

1.1 ERACLE 8 Operation Modes:

MODE	Indication
Normal	• Only the “POWER SUPPLY 230V” green LED is illuminated.
Fire	<ul style="list-style-type: none"> • The “FIRE” red LED and the zone red LED will flash together on receipt of a FIRE condition and become steady after the “SILENCE ALARM” button is pressed. • An internal buzzer will operate until silenced. • The external sounders will operate. • The FIRE relay will energize.
Fault	<ul style="list-style-type: none"> • The “GENERAL FAULT” yellow LED will illuminate together with a zone yellow LED or any of the FAULTS LED. • An internal buzzer will sound. • The FAULT relay will de-energize.

1.2 LED indication for the status of the zones (1-8):

ZONE LED	Indication
Red	Fire in the zone.
Yellow	Technical fault in the zone - open or short circuit; detector removed from its base. Zone test - the LED is flashing during the test procedure.







1.3 LED indication for the technical faults in the system:

FAULT	Fault description
Sounder 1	Sounder Circuit One fault - open or short circuit, reverse connected sounder, or bad sounder parameters.
Sounder 2	Sounder Circuit Two fault - open or short circuit, reverse connected sounder, or bad sounder parameters.
+24V DC Overload	Overload of “+24” VDC power supply.
+24V DC Failed	Absence of “+24” VDC power supply.
Battery Low	Low battery condition; broken battery (high battery resistance).
Battery Lost	Battery loss.
AC	Mains Supply loss.
Charger	Battery charger fault.
AUX	Auxiliary supply fault.
Earth	Short circuit to earth.
Repeater	Repeater fault or missing.

1.4 LED indication for the system status:

LED	Indication
FIRE <i>(red)</i>	Fire in the premises.
GENERAL FAULT <i>(yellow)</i>	Main Fault indicator.
OUTPUT DELAY <i>(yellow)</i>	Lights permanently at programmed outputs time delay (a jumper is set on the TIME DELAY terminal).
µP FAULT <i>(yellow)</i>	Processor break down.
SOUNDER FAULT/DISABLE <i>(yellow)</i>	Trouble in the sounder circuit - open or short circuit; reverse connected sounder.
ENABLE / DISABLE <i>(yellow)</i>	Lights permanently at disabled zones/sounders. Blinks during enabling/disabling of zones or sounders.
TEST <i>(yellow)</i>	Blinks during "One Man" Test together with the LED of the tested zone.
POWER SUPPLY 230V <i>(green)</i>	Lights on permanently in normal operating mode, indicates presence of main power supply 230V.

1.5 Buttons for programming and operation:

Button	Description
 SILENCE BUZZER	Deactivating the internal buzzer.
 SILENCE ALARM	Deactivating sounders.
 ENABLE / DISABLE	Enabling / Disabling of Zones / Sounders.
 TEST / SCROLL	Test mode; Scroll forward zones.
 RESET	Initialization; Confirm the introduced changes.
 SOUND ALARM	Activating sounders.

1.6 Switch for changing over between Access Levels 1 and 2:

Position	Description
OFF	Access Level 1 - only the "SILENCE BUZZER" button is active.
ON	Access Level 2 - all buttons at the front panel are active.

2. Installing the ERACLE 8 Panel

- Choose the best location for the panel position, with an ambient temperature between -5°C and 40°C, away from heating sources, environmental dust and potential water ingress.
- Remove all packaging and inspect visually the panel for any damage.
- Remove the outer cover - undo the two screws at the bottom of the cover. Stow the cover in a safe position.
- Inspect the internal PCB and make sure the internal components are firmly in place.
- Remove the PCB from the plastic box. Stow in a safe location.
- Choose which cable entry points to knock out and carefully remove the knock-outs.
- Use the template on the back side of the packaging box to drill the mounting holes on the wall.
- Fix the plastic housing into mounting position and insert fixing screws.
- Tighten all the fixing screws.
- Route the external cables onto the back box, make off connection glands etc., **DO NOT make any connections at this stage. ENTER THE MAINS CABLE THROUGH ITS OWN CABLE ENTRY POINT AND KEEP MAINS WIRING AWAY FROM SYSTEM AND OTHER LOW VOLTAGE WIRING.**
- Fit the EOL modules from the supplied additional parts one-by-one to every zone terminal. **ATTENTION: Observe the polarity - the red wire to “+” point and the black wire to “-” point.**
- Fit the EOL resistors from the supplied additional parts one-by-one to the sounders terminal.
- Re-fit the PCB to the plastic box.
- Connect the mains supply and earth to the main terminal block. **DO NOT** switch on the main electrical supply at this stage.
- Position the battery in an upright position.
- When you finish with power up and testing steps, and the panel is in normal operation mode close the front cover using the screws and nuts from the spare parts kit:

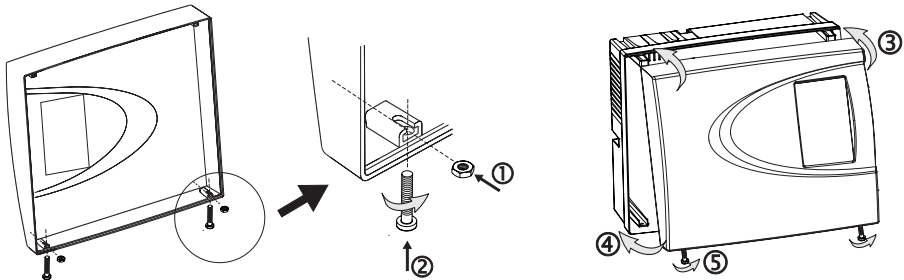
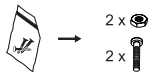

3. Initial Power-up of ERACLE 8 Panel



ATTENTION: It has been assumed that prior to making the connection at the panel, the integrity of the system ALL wiring has been comprehensively tested, including insulation to earth.

- Connect the battery leads from the power supply box to the positive and negative battery terminals.
- Switch on the mains power supply.
- If the buzzer and indicator LED's are operating, press the RESET button.
- The panel must be in Normal Operation Mode - only POWER SUPPLY 230V will be illuminated. **NOTE:** The "Battery Low" LED might light on initially until the battery is charging up to the required level.



If in Normal Operating Mode other LED's are illuminated and the buzzer is sounding, carefully check all fuses and connections. Refer to the Faults and System status LED description and the connection diagram on the inside of the external cover will assist in identifying the trouble.



ATTENTION: Do not short out the battery terminals because any internal protection will switch on and the panel will stop function!

4. Connecting the Zone Circuits

- Disconnect the mains power supply and the battery connection.
- Remove the EOL-module from the Zone 1 terminal on the main module and fit it to the last detector of the Zone 1 circuit as observe the polarity:

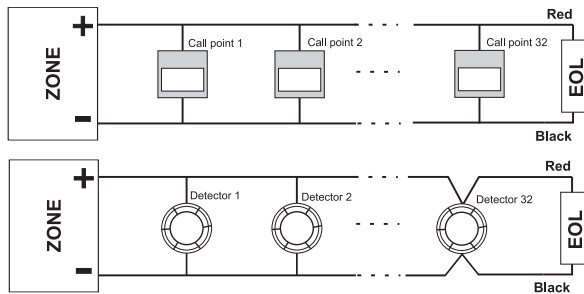

- Ensure all terminations are made correctly and all detector heads are set into their bases.
- Connect Zone 1 circuit to the panel terminal block.
- Power up the panel with the mains and battery.
- Press "⏸ RESET" button.
- The panel is in Normal Operation Mode - only POWER SUPPLY 230V lights on.



If General Fault and zone 1 FAULT LED's illuminate, there is a wiring/connection problem. Check the polarity of the connection, the connection of the devices and whether a head is removed. Check the EOL proper polarity and position.

- Operate ALL detection devices applicable to this zone, to ensure correct receipt of a fire signal and the correct operation of the panel controls. Refer to the User Instructions on the inside of the panel.
- Repeat the connection process for the other zones stated above. ENSURE the supply voltages are initially disconnected prior to each stage.



Once the connections of all zones are completed, connect and test any of the other auxiliary circuits BEFORE connecting the sounder circuits.

5. Connecting the Sounder Circuits

- Disconnect the mains power supply and the battery connection.
- Remove the EOL-Resistor from the terminal block of sounder circuit 1 (SND 1) and fit to the last sounder of circuit one:

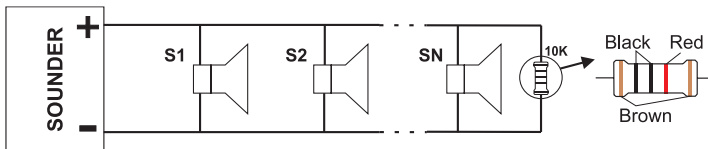

- Check all sounder connections.
- Connect sounder circuit ONE to the panel terminal block.
- Apply mains and battery power.
- Press “ RESET” button.
- The panel must be in Normal Operation Mode - only POWER SUPPLY 230V will be illuminated.
- Activate a zone Call Point. The sounders should operate. Press the RESET button. Repeat the connection process for the second external sounder circuit, as stated above. ENSURE the supply voltages are initially disconnected prior to each stage.



If GENERAL FAULT and SOUNDER FAULT/DISABLE LED's illuminate, there is a wiring/ connection problem. Check the polarity of the connection of each of the devices, the polarity of the connection of the devices to the Panel terminal block or whether an earth fault exists.

6. Connecting FAULT and FIRE Relay Circuits

The relays with changeover contacts are intended for control of low voltage devices.



Attention: No mains power should be supplied to the clamps of the FAULT and FIRE relays. After the connection is established, test each of the circuits for external device control.

7. Class Change Function

To use the class change function connect the terminals of a switch with normally open contacts to the CC (Class Change) clamps of the main module terminal. The working mode of the sounders will be:

- when the switch is pressed - one second sounder on, one second sounder off;
- when the switch is depressed - the sounder is off.



8. Connecting of Repeater Panel

A second ERACLE 8 can be connected to the ERACLE 8 Fire Alarm panel as a Repeater (Slave) panel. The function of the Repeater is to double the light and sound indication and the button control of the first panel at a distance up to 1000 m. For the purpose, to both of the panels have to be assigned specific priorities: The first fire alarm panel shall be the system Master and the second - Slave.

The Master panel is configured by setting a jumper on the Master position of the main module, and the Slave - with a jumper on the Slave position of the main module (see the connection diagram on page 16).

To add a repeater panel in the fire system follow the steps:

- Turn off the main and the stand-by power supplies.
- Connect the repeater to the main ERACLE 8 using the repeater interface:
- Turn on the main and the stand-by power supplies of the Slave panel.
- Turn on the main and the stand-by power supplies of the Master panel.

-  jumper removed – the option is disabled
-  jumper set – the option is enabled

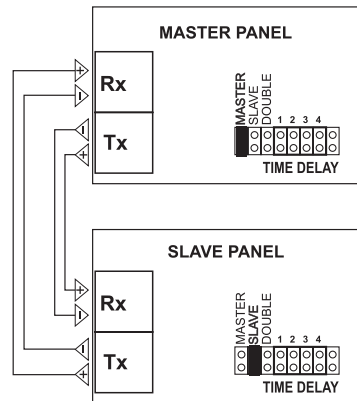

9. Programming Master Panel Mode

In order to program the Master Panel mode:

- Set a jumper on the **Master** position of the main module.
- Press the “⏸ RESET” button to introduce changes.

10. Programming Repeater Panel Mode

In order to program the Repeater Panel mode:

- Set a jumper on the **Slave** position of the main panel module.
- Check for jumper on the **Wireless** terminal and remove if present.
- Press the “⏸ RESET” button to introduce changes.

11. Programming Single Panel Mode

No jumper is set on the Master or Slave position in Single Panel Mode of the ERACLE 8.

In order to program the Single Panel mode:

- Check whether there are jumpers set on the Master or Slave position. Remove if any.
- Press the “⏸ RESET” button to introduce changes.

12. Sounder Delay Mode

This is an option for setting a delay on the Sounders activation when the panel enters FIRE mode. The indication on the front panel - the FIRE LED, however, will light up immediately in case of a fire event, regardless of whether a sounder delay has been set. When the programmed sounder delay period expires, during which the user can possibly find out the cause for the alarm event, the panel enables the sounders. The sounders can be silenced by pressing the “ SILENCE ALARM” button on the front panel.

In case of a false fire alarm the user must press the “ RESET” button to return to normal working mode.

Attention: The fire alarm panel ERACLE 8 is capable to distinguish the activation of automatic fire alarm detector and call point. In case of call point activation, the programmed sounder time delay will be ignored and the sounders will be activated immediately.

In order to program ERACLE 8 for Sounder Delay for an interval up to 10 minutes:

- Examine the Table for Sounder Delay Programming (in minutes):

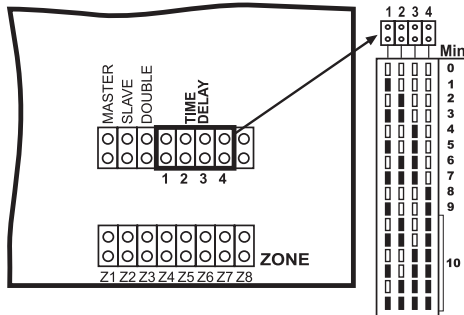

- Depending on the selected time delay, set a jumper at the TIME DELAY terminals, marked in Figure 10 as 1, 2, 3, and 4.
- Press the “ RESET” button to introduce changes.

Example: In order to program sounder delay of 3 minutes, set jumpers on positions 1 and 2.

13. Double Action Mode

The purpose of introducing a Double Action mode is to avoid false alarms. When the ERACLE 8 panel has been programmed to function in this mode, in case of a fire alarm signal, the panel does not starting the sounders at once and waits for the alarm event to be repeated within a specific time interval. The time interval has been set by default and cannot be adjusted. For ERACLE 8 it is 3 minutes.

Attention: The fire alarm panel ERACLE 8 is capable to distinguish the activation of automatic fire alarm detector and call point. In case of call point activation, the programmed DOUBLE Action mode will be ignored and the sounders will be activated immediately.

In order to program the ERACLE 8 panel for Double Action mode:

- Set a jumper on the DOUBLE terminal of the main module.
- Press the “(II) RESET” button to introduce changes.

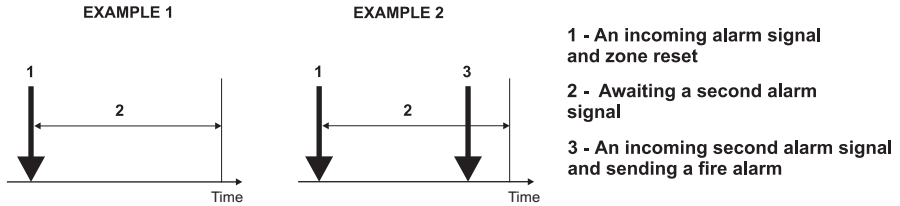

Example 1: In this case the fire panel will not activate the sounders and the signalization on the front panel because during time interval 2 no second alarm signal is generated.

Example 2: In this case the fire panel will activate the sounders and the signalization on the front panel because during time interval 2, two alarm signals are generated.

14. Instant Action Mode

Where in the protected site there are zones, which need the sounders and the LED indication to be enabled instantaneously, the panel provides instant action operation mode. This mode can be programmed individually for every single zone, depending on its designation. In instant action mode, in case of an alarm event occurring in the zone, the sounders are immediately enabled, i.e. **this mode is of priority by zones compared to Double Action and Sounder Delay modes.**

In order to program Instant Action mode for a selected zone:



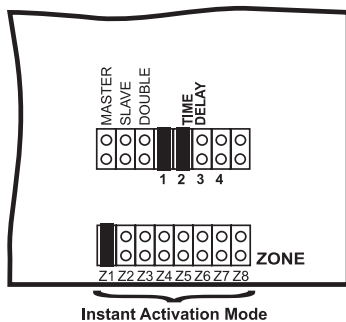

- Set a jumper on the terminal that corresponds to the number of the zone.
- Press the “(II) RESET” button to introduce changes.

Example: If the designation of ZONE 1 requires instant activation of all automatic fire alarm detectors connected in the line, set a jumper at Z1 terminals.



15. Operating Instructions

15.1 Sound Signalization





Signal	Description
Short beeps	After pressing the “  RESET” button and upon the initial start-up of the panel.
Continuous beep	Fire and/ or Fault operating mode. The signal can be stopped by pressing the “  SILENCE BUZZER” button, but the LED indication remains.
Interrupted beep	After pressing the “  ENABLE/DISABLE” button to enable/disable zones/sounders and the “  TEST/SCROLL” button to access “One Man” test mode of zones. The signal can be stopped by pressing the “  SILENCE BUZZER” button, but the LED indication remains.

15.2 Service Modes





Zone Enable / Disable

Each zone of ERACLE 8 can be enabled or disabled.

To disable a zone:

• Press  ENABLE/ DISABLE:	DISABLE/ ENABLE LED blinks. <i>The ZONE 1 yellow LED blinks if ZONE 1 is enabled and lights permanently if ZONE 1 is disabled.</i>
• Press  TEST/ SCROLL, until you reach the zone which has to be disabled:	<i>The respective zone yellow LED blinks.</i>
• Press  ENABLE/ DISABLE:	<i>The yellow LED of the disabled zone lights up permanently.</i>
• Press  RESET:	<i>At this step the zone is disabled.</i>

To enable a zone:





• Press  ENABLE/ DISABLE:	DISABLE/ ENABLE LED blinks. <i>The ZONE 1 yellow LED blinks if ZONE 1 is enabled and lights permanently if ZONE 1 is disabled.</i>
• Press  TEST/SCROLL, until you reach the zone which has to enable:	<i>The yellow LED of the disabled zone lights up permanently.</i>
• Press  ENABLE/ DISABLE:	<i>The yellow LED of the enabled zone blinks.</i>
• Press  RESET:	<i>At this step the zone is enabled.</i>

Sounders Enable / Disable







A sound signalization is activated at every Service Mode entering. The signalization is off by pressing “ SILENCE BUZZER” button.

 **To disable the sounders:**

<ul style="list-style-type: none"> • Press  ENABLE/ DISABLE: 	<p>DISABLE/ ENABLE LED blinks. <i>The ZONE 1 yellow LED blinks if ZONE 1 is enabled and lights permanently if ZONE 1 is disabled.</i></p>
<ul style="list-style-type: none"> • Press  TEST/ SCROLL, until you reach the last zone in the system: 	<p><i>The SOUNDER FAULT/DISABLE LED will start blinking.</i></p>
<ul style="list-style-type: none"> • Press  ENABLE/ DISABLE: 	<p><i>The SOUNDER FAULT/DISABLE LED lights up permanently.</i></p>
<ul style="list-style-type: none"> • Press  RESET: 	<p><i>The SOUNDER FAULT/DISABLE and ENABLE/DISABLE LEDs light up permanently. At this step the sounders are disabled.</i></p>

You can exit the sounder disabling mode also by pressing the “ TEST/ SCROLL” button, as in that case the you reject the procedure.

 **To enable the sounders:**



<ul style="list-style-type: none"> • Press  ENABLE/ DISABLE: 	<p>DISABLE/ ENABLE LED blinks. <i>The ZONE 1 yellow LED blinks if ZONE 1 is enabled and lights permanently if ZONE 1 is disabled.</i></p>
<ul style="list-style-type: none"> • Press  TEST/ SCROLL, until you reach the last zone in the system: 	<p><i>The SOUNDER FAULT/DISABLE LED lights up permanently.</i></p>
<ul style="list-style-type: none"> • Press  ENABLE/ DISABLE: 	<p><i>The SOUNDER FAULT/DISABLE LED will start blinking.</i></p>
<ul style="list-style-type: none"> • Press  RESET: 	<p><i>At this step the sounders are enabled.</i></p>



You can exit the sounder enabling mode also by pressing the “ TEST/ SCROLL” button, as in that case the you reject the procedure.

“One Man” Test

The “One Man” Test mode gives the installer the possibility to test the efficiency of the system - whether the detectors react to smoke, heat, etc.

To “One Man” Test a zone:

<ul style="list-style-type: none"> • Press  TEST/ SCROLL: 	<p>TEST LED will start blinking. µP Fault LED lights off. All other system indication LEDs light on permanently.</p>
<ul style="list-style-type: none"> • Press  TEST/ SCROLL again: 	<p>The ZONE 1 yellow LED starts blinking. ZONE 1 is in test mode. Test a detector from this zone whether it react to smoke, heat, etc.</p>
<ul style="list-style-type: none"> • Press  TEST/ SCROLL again to continue with the system testing: 	<p>TEST LED will continue blinking. The ZONE 1 yellow LED lights out (the zone is not longer in test mode). The ZONE 2 yellow LED blinks in yellow. ZONE 2 is in test mode. Test a detector from this zone whether it react to smoke, heat, etc.</p>

Continue the system testing by pressing the “ TEST/ SCROLL” button. The exit from the “One Man” Test mode is automatic after the end of the test procedure in the last Zone 8, or at any time by pressing “ RESET” button.

Quick Reference Operation Examples

• To disable Zone 3, do in sequence:

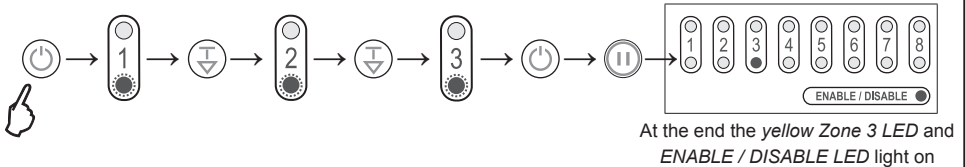

To enable back the Zone 3 do the same steps. At the end the Zone 3 and ENABLE / DISABLE LED are off.

• To disable the sounders, do in sequence:

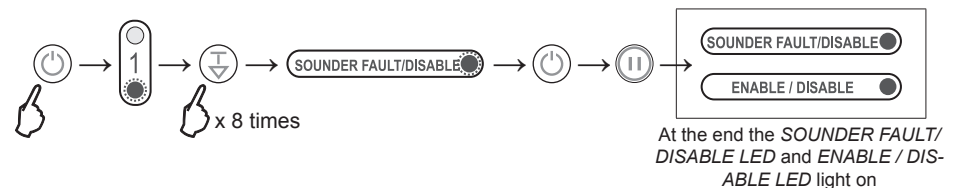

To enable back the sounders do the same steps. At the end the SOUNDER FAULT/ DISABLE and ENABLE / DISABLE LED are off.

LEGEND: ○ - The LED is off; ● - The LED is on; ● (with dot) - The LED blinks

17. Connection Diagram

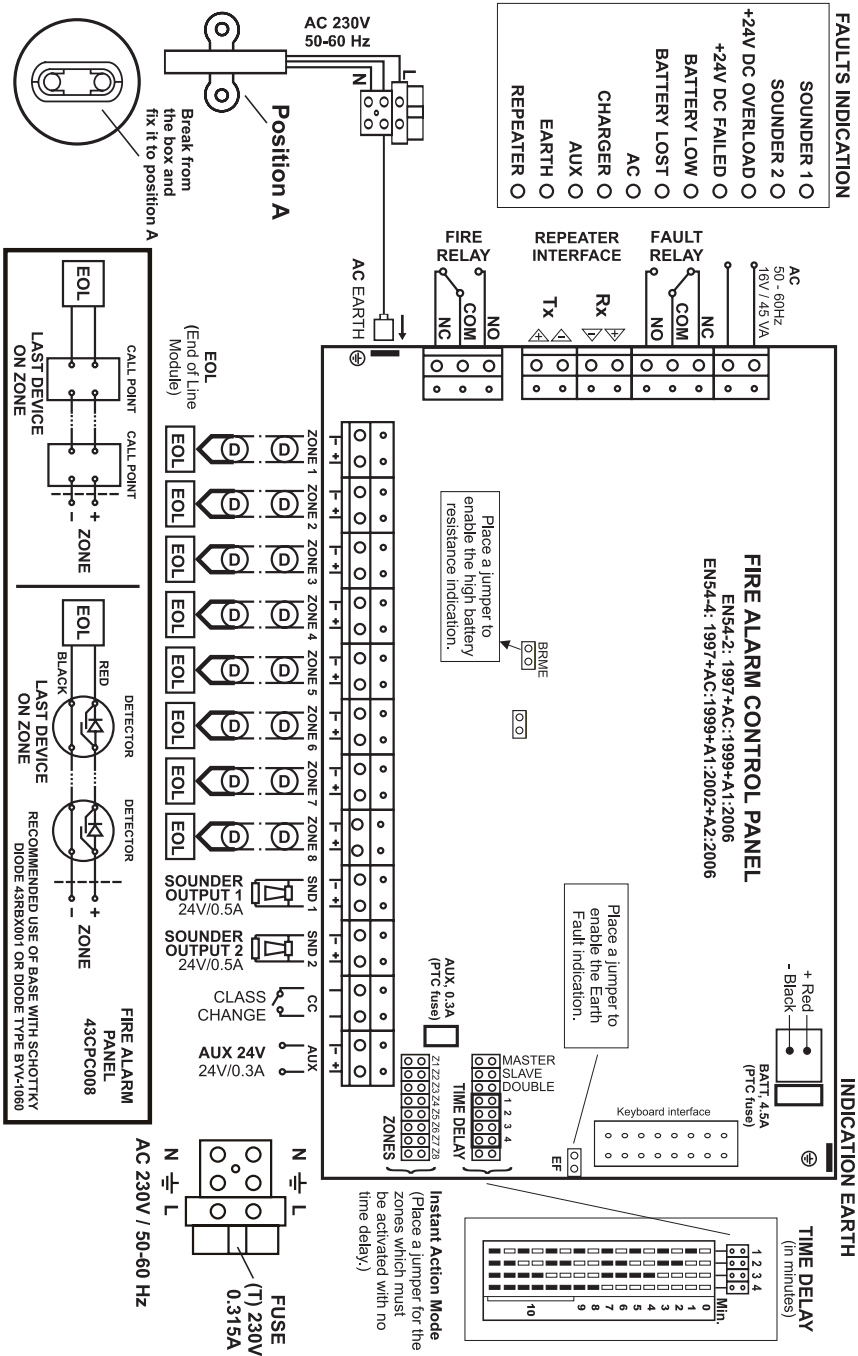

18. Technical Specifications

Zones	8 fixed zones
Maximum number of detectors per zone	Up to 32 devices*
* Up to 20 (or 32 ERACLE series detectors: 43RCS001, 43RCS000, 43RFU000, 43RML000) conventional detectors and unlimited number of manual call points.	
Thresholds for zone conditions	
• 0 - 2 mA	Open circuit fault condition.
• 2 - 10 mA	Normal condition.
• 10 - 110 mA	Fire Alarm condition.
• 110 mA - Short circuit	Short circuit condition.
Power Supply	
Main Power supply	230V AC $\pm 10\%$; 0.315A fuse
Standby Power supply, accumulator	1 x 12V/7Ah (7.2Ah); 4.5A fuse type Sealed Lead-Acid, 150x95x65mm
Maximum charging current for the battery	0.3 A
Battery high resistance Ri	< 0.45 Ω
Consumption	
Maximum current available for system devices (with fully charged battery)	0.7 A
Minimum current for standby power supply - mains failure	0.125 A
Maximum current for standby power supply	4,5 A
Outputs	
Sounder Circuit 1	24V / 0.5A; 0.5A fuse (PTC)
Sounder Circuit 2	24V / 0.5A; 0.5A fuse (PTC)
Fault Relay, volt free changeover contacts**	3A @ 24V DC
Fire Relay, volt free changeover contacts**	3A @ 24V DC
** Note: These functions may not be used to provide any "Options with requirements" as specified in EN 54-2.	
Auxiliary output	24V DC, 0.3A fuse (PTC)
Cabling	Maximum 2.5mm diameter
Environment	
Working temperature	-5 to 40°C
Storage temperature	-20 to 60°C
Humidity	0 to 95%
Compatible modules	
43ECR032 - 8 Relay Module	
43LEC000 - Log Memory Module	
Attention: It is possible to connect only one module to the ERACLE 8 fire panel at the same time!	

FIRE ALARM RECORD

Installation Address:

Contact Person:

Telephone:

Fax:

Date Completed:

Commissioned By:

Contract Reference:

Service Intervals: Monthly / Quarterly / Half Yearly / Annually

ZONE No	LOCATION	DETECTOR TYPE and QUANTITY PER ZONE					SOUNDERS (Zone Quantity and Related Circuit)	
		Ion	Ph	RoR	F/T	CP	Circuit1	Circuit2
1								
2								
3								
4								
5								
6								
7								
8								
	TOTALS:							

* **Ion** - Ionisation sensor, **Ph** - Photoelectric sensor, **RoR** - Rate of Rise sensor, **F/T** - Fixed Temperature sensor, **CP** - Call Point

System Installed By:

Telephone / Fax:







SERVICE RECORD

Date Visit Completed	Zones Tested	Faults Rectified	Signature of Engineer	Next Due
	1 2 3 4 5 6 7 8		Name:	
	1 2 3 4 5 6 7 8		Name:	
	1 2 3 4 5 6 7 8		Name:	
	1 2 3 4 5 6 7 8		Name:	

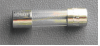
FIRE ALARM EVENT LOG

DATE	TIME	FIRE yes / no	ZONE number	FAULT yes/no and TYPE	ACTION TAKEN	Name

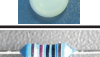
SPARE PARTS KIT

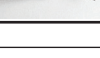
No	Component	Description	Q-ty
1		Fuse 0.315A, 5x20	1
2		Key, 10mm	2
3		Screw, 2.9x13 mm, DIN7981	2
4		Screw with interrupted thread, M3x16	2
5		Locknut, M3	2
6		Plastic cap, 20mm	4
7		Resistor 10K ±1%, 0,25W	3
8		EOL Module	9

Comelit Group S.p.A.

Via Don Arrigoni 5 - 24020 Rovetta S. Lorenzo BG Italy

tel. +39 0346 750 011; fax +39 0346 71436

www.comelitgroup.com - info@comelit.it

