

ERACLE 2/4

43CPC002EN

43CPC004EN

**CONVENTIONAL FIRE ALARM
CONTROL PANEL
WITH 2 AND 4 ZONES**

**INSTALLATION AND
OPERATION MANUAL**

CE 1293



Comelit[®]
Passion. Technology. Design.

CONTENTS

1. Using the ERACLE 2/4 controls	4
1.1 Operation modes	5
1.2 LED indication for zones status	5
1.3 LED indication for the technical troubles	5
1.4 LED indication for the system status	6
1.5 Buttons for programming and operation	6
1.6 Switch for changing over between Access Levels 1 and 3	6
1.7 Sound signalization	7
2. Installing the ERACLE 2/4 fire panels	7
3. Testing the ERACLE 2/4 fire panels	8
4. Connecting the zone circuits	8
5. Connecting the sounders circuits	9
6. Connecting the FAULT and FIRE relays	9
7. Class Change Function	9
8. Operation instructions	10
8.1 Zone Enabling/ Disabling	10
8.2 Sounders Enabling/ Disabling	10
8.3 "One man" zone testing	11
9. Technical specifications	12
10. Connection diagrams	13
11. Fire alarm record	14
12. Service record	14
13. Fire alarm event LOG	15
14. Spare parts kits	15



DoP No: 007

Comelit Group S.p.A. Via Don Arrigoni 5 - 24020 Rovetta S. Lorenzo BG Italy

EN 54-2:1997/A1:2006/AC:1999; EN 54-4:1997/A2:2006/AC:1999

ERACLE 2/4

Intended for use in fire detection and fire alarm systems in and around buildings.

Essential Characteristics	Performance
Performance under fire conditions	Pass
Response delay (response time to fire)	Pass
Operational reliability	Pass
Durability of operational reliability and response delay: temperature resistance	Pass
Durability of operational reliability: humidity resistance	Pass
Durability of operational reliability: vibration resistance	Pass
Durability of operational reliability: electrical resistance	Pass



This manual contains information on limitations regarding product use and function and information on the limitations as to liability of the manufacturer.

The entire manual should be carefully read!

WARNING

The system is to be installed by a qualified person to the latest Fire Alarm and Installation Regulations which are mandatory in the applicable country of installation.

Before commencing the installation of this Fire Alarm Panel, ensure it is sited in a position, which is visible to the Fire Brigade when entering the premises, and where ease of access is provided for users and service engineers. Space must be available to easily open external and internal doors.

The Electrical Supply to the panel must be isolated and must not be capable of being accidentally switched off. A 'Lockable Switch fuse Unit' positioned within 2 meters of the panel should be clearly labelled FIRE ALARM - DO NOT SWITCH OFF.

EN 54-2 compatible panels.

All specifications are subject to change without notice.

1. Using the ERACLE 2/4 controls

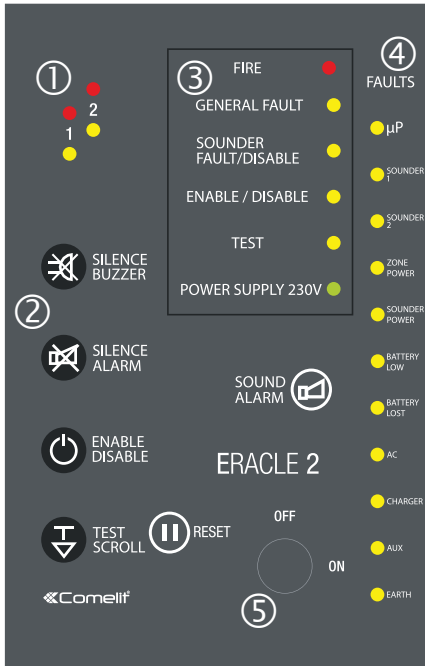

Front view ERACLE 2

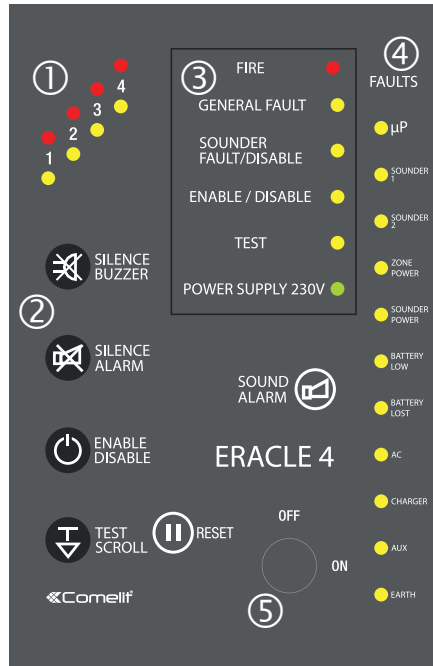

Front view ERACLE 4

Description of the front panels elements:

①	LED indication for the zones status: ERACLE 2 - 2 zones ERACLE 4 - 4 zones
②	Buttons for programming and operation, see item 1.5.
③	LED indication for the system status, see item 1.4.
④	LED indication for the technical troubles - see item 1.3. Note: This indication is not visible for the user. To examine the technical troubles in the system, the engineer has to remove the front cover of the box.
⑤	Switch for changing over between Access Levels 1 and 2 - see item 1.6.

1.1 Operation modes:

MODE	Indication
Normal	<ul style="list-style-type: none"> • The green LED next to the 'power Supply 230V AC' will be illuminated.
Fire	<ul style="list-style-type: none"> • The integrated red status FIRE LED and a zone identification LED will flash together on receipt of a FIRE condition and become steady after the SILENCE ALARM button is pressed. • An internal buzzer will operate until silenced with SILENCE BUZZER button. • The external sounders will operate. • The FIRE relay on the main board will energize.
Fault	<ul style="list-style-type: none"> • The yellow GENERAL FAULT LED will always illuminate together with an external or internal identification LED. • An internal buzzer will sound. • The FAULT relay on the main will de-energize.

1.2 LED indication for the zones status:

ZONE LED	Indication
Red	<ul style="list-style-type: none"> • Fire alarm in the zone.
Yellow	<ul style="list-style-type: none"> • Zone fault - open or short circuit. Detector head removed. • Zone test - the LED is blinking during the test procedure.

1.3 LED indication for the technical faults:







FAULT	Fault description
○ µP	Processor break down.
○ Sounder 1	Sounder Circuit One fault - open or short circuit, reverse connected sounder, or bad sounder parameters.
○ Sounder 2	Sounder Circuit Two fault - open or short circuit, reverse connected sounder, or bad sounder parameters.
○ Zone Power	Overload of "+24" VDC power supply.
○ Sounder Power	Absence of "+24" VDC power supply.
○ Battery Low	Low battery condition.
○ Battery Lost	Battery loss.
○ AC	Mains Supply loss.
○ Charger	Battery charger fault.
○ AUX	Auxiliary supply fault.
○ Earth	Short circuit to earth.

Battery Low, Battery Lost and Charger LEDs are lighting up together in case of overload of the battery charger output.

1.4 LED indication for the system status:

LED	Indication
FIRE (red)	Fire in the premises.
GENERAL FAULT* (yellow)	Main Fault indicator.
SOUNDER FAULT/DISABLE* (yellow)	Trouble in the sounder circuit - open or short circuit; reverse connected sounder.
ENABLE / DISABLE (yellow)	Lights permanently at disabled zones/sounders. Blinks during enabling/disabling of zones or sounders.
TEST (yellow)	Blinks during "One Man" Test together with the LED of the tested zone.
POWER SUPPLY 230V (green)	Lights on permanently in normal operating mode, indicates presence of main power supply 230V.

1.5 Buttons for programming and operation:

Button	Description
 SILENCE BUZZER	Deactivating the internal buzzer.
 SILENCE ALARM	Deactivating sounders.
 ENABLE / DISABLE	Enabling / Disabling of Zones / Sounders.
 TEST / SCROLL	Test mode; Scroll forward zones.
 RESET	Initialization; Confirm the introduced changes.
 SOUND ALARM	Activating sounders.

1.6 Switch for changing over between Access Levels 1 and 2:

Position	Description
OFF	Access Level 1 - only the "SILENCE BUZZER" button is active.
ON	Access Level 2 - all buttons at the front panel are active.

** NOTE: Fault conditions will not be announced instantly. There will be a short delay which will vary from condition to condition. Faults when cleared will automatically reset at the panel.*

1.7 Sound signalization

Signal	Description
Short beeps	After pressing the “RESET” button and upon the initial start-up of the panel.
Continuous beep	Fire and/ or Fault operating mode. The signal can be stopped by pressing the “SILENCE BUZZER” button, but the LED indication remains.
Interrupted beep	After pressing the “ENABLE/DISABLE” button to enable/disable zones/ sounders and the “TEST/SCROLL” button to access “One Man” test mode of zones. The signal can be stopped by pressing the “SILENCE BUZZER” button, but the LED indication remains.

2. Installing the ERACLE 2/4 fire panels

- Choose the best location for the panel position, with an ambient temperature between -5°C and 40°C, away from heating sources, environmental dust and potential water ingress.
 - Remove all packaging and inspect visually the panel for any damage.
 - Remove the outer cover. Stow the cover in a safe position.
 - Inspect the internal PCB and make sure the internal components are firmly in place.
 - Remove the PCB from the carrier. Stow in a safe location.
 - Choose which cable entry points to use for the installation wires.
 - Drill the wall to suit the back box centre fixing position, plug and insert a fixing screw.
- Note:** For the installation use the template on the back side of the packaging box to drill the mounting holes on the wall.
- Fix the plastic housing into mounting position and insert fixing screws.
 - Tighten all the fixing screws.
 - Route the external cables onto the back box, make off connection glands etc., **DO NOT make any connections at this stage. ENTER THE MAINS CABLE THROUGH ITS OWN CABLE ENTRY POINT AND KEEP MAINS WIRING AWAY FROM SYSTEM AND OTHER LOW VOLTAGE WIRING.**
 - Fit the EOL modules from the supplied additional parts one-by-one to every zone terminal. **ATTENTION: Observe the polarity - the red wire to “+” point and the black wire to “-” point.**
 - Fit the EOL resistors from the supplied additional parts one-by-one to the sounders terminal.
 - Re-fit the PCB to the box.
 - Place the temperature sensor behind or under the accumulator battery.
 - Connect the mains supply and earth to the main terminal block. **DO NOT** switch on the main electrical supply at this stage.
 - Position the battery in an upright position and place the temperature sensor behind it.
 - Close the outer cover using the nuts and screws from the spare parts kit:

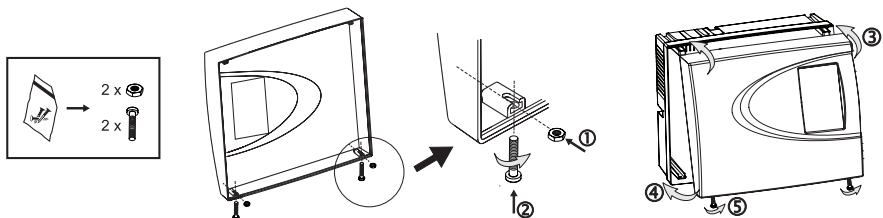

3. Testing the ERACLE 2/4 fire panels



ATTENTION: It has been assumed that prior to making the connection at the panel, the integrity of the system ALL wiring has been comprehensively tested, including insulation to earth.

- Switch on the mains power supply.
- Connect the battery leads from the black power supply box to the positive and negative battery terminals.
- If the buzzer and indicator LED's are operating, press the RESET button.

In Normal Operating Mode only POWER SUPPLY 230V will be illuminated.

NOTE: The battery might show a 'Low Battery Fault' initially until it has had time to charge up to the required level.



If other LEDs are illuminated and the buzzer is sounding, carefully check all fuses and connections. Refer to the page 7 for the associated yellow LED's apply to. The connection diagram on the inside of the external cover will assist in identifying the LED.



ATTENTION: Do not short out the battery terminals because an internal protection will switch on and the panel will stop function!

If by some chance the fault will not cancel, and only on the advice of our Technical Support Department, return the PCB CHASSIS ONLY to your supplier. DO NOT return the plastic box.

4. Connecting the zones circuits

- Disconnect the mains power supply and the battery connection.
- Remove the EOL-module from the zone 1 terminal on the main module and fit it to the last detector of the the zone 1 circuit as observe the polarity:

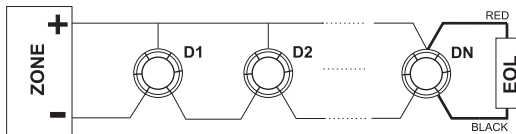

- Ensure all terminations are made correctly and all detector heads are plugged into their bases.
- Connect Detector circuit ONE to the panel terminal block.
- Power up the panel with the mains and battery.
- Press RESET button.

The panel should be in the 'NORMAL MODE'.



If General Fault and zone 1 FAULT LED's illuminate, there is a wiring/connection problem. Check the polarity of the connection, the connection of the devices and whether a head is removed. Check the EOL proper polarity and position.

- Operate ALL detection devices applicable to this zone, to ensure correct receipt of a fire signal and the correct operation of the panel controls. Refer to the User Instructions on the inside of the panel.
- Repeat the connection process for the other zones stated above. ENSURE the supply voltages are initially disconnected prior to each stage.



Once the connection of the zones is completed, connect and test any of the other auxiliary circuits BEFORE connecting the external sounder circuits.

5. Connecting the sounders circuits

- Disconnect the mains power supply and the battery connection.
- Remove the EOL-Resistor from the terminal block of sounder circuit 1 (SND 1) and fit to the last sounder of circuit one:

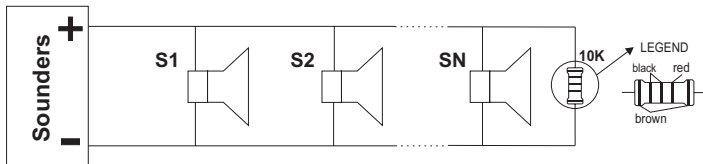

- Check all sounder connections are made.
- Connect sounder circuit ONE to the panel terminal block.
- Apply mains and battery power.
- Press RESET.

The panel should be in the 'NORMAL MODE'.

- Activate a zone Call Point. The sounders should operate. Press the RESET button. Repeat the connection process for the second external sounder circuit, as stated above. ENSURE the supply voltages are initially disconnected prior to each stage.



If General Fault and SOUNDER FAULT / DISABLE LED's illuminate, there is a wiring / connection problem. Check the polarity of the connection of each of the devices, the polarity of the connection of the devices to the Panel terminal block or whether an earth fault exists.

6. Connecting the FAULT and FIRE relay circuits

FAULT and FIRE Relays - The on board relays volt free change over terminals are for low voltage use only. **Attention: Mains supply MUST NOT BE APPLIED to these terminals.**

7. Class Change Function

To use the class change function connect the terminals of a switch with normally open contacts to the CC (Class Change) clamps of the main module terminal. The working mode of the sounders will be:

- when the switch is pressed - one second sounder on, one second sounder off;
- when the switch is depressed - the sounder is off.

8. Operation instructions

8.1 Zone Enabling/ Disabling

To disable a zone:

• Press ENABLE/ DISABLE:	DISABLE/ ENABLE LED blinks. The ZONE 1 yellow LED blinks if ZONE 1 is enabled and lights permanently if ZONE 1 is disabled.
• Press TEST/ SCROLL, until you reach the zone which has to be disabled:	The respective zone yellow LED blinks.
• Press ENABLE/ DISABLE:	The yellow LED of the disabled zone lights up permanently.
• Press RESET:	At this step the zone is disabled.

To enable a zone:

• Press ENABLE/ DISABLE:	DISABLE/ ENABLE LED blinks. The ZONE 1 yellow LED blinks if ZONE 1 is enabled and lights permanently if ZONE 1 is disabled.
• Press TEST/SCROLL, until you reach the zone which has to enable:	The yellow LED of the disabled zone lights up permanently.
• Press ENABLE/ DISABLE:	The yellow LED of the enabled zone blinks.
• Press RESET:	At this step the zone is enabled.

8.2 Sounders Enabling/ Disabling



A sound signalization is activated at every Service Mode entering. The signalization is off by pressing “SILENCE BUZZER” button.

To disable the sounders:

• Press ENABLE/ DISABLE:	DISABLE/ ENABLE LED blinks. The ZONE 1 yellow LED blinks if ZONE 1 is enabled and lights permanently if ZONE 1 is disabled.
• Press TEST/ SCROLL, until you reach the last zone in the system:	The SOUNDER FAULT/DISABLE LED will start blinking.
• Press ENABLE/ DISABLE:	The SOUNDER FAULT/DISABLE LED lights up permanently.

• Press RESET:	<i>The SOUNDER FAULT/DISABLE and ENABLE/DISABLE LEDs light up permanently. At this step the sounders are disabled.</i>
----------------	---

You can exit the sounder disabling mode also by pressing the “TEST/ SCROLL” button, as in that case the you reject the procedure.

☞ To enable the sounders:

• Press ENABLE/ DISABLE:	<i>DISABLE/ ENABLE LED blinks. The ZONE 1 yellow LED blinks if ZONE 1 is enabled and lights permanently if ZONE 1 is disabled.</i>
• Press TEST/ SCROLL, until you reach the last zone in the system:	<i>The SOUNDER FAULT/DISABLE LED lights up permanently.</i>
• Press ENABLE/ DISABLE:	<i>The SOUNDER FAULT/DISABLE LED will start blinking.</i>
• Press RESET:	<i>At this step the sounders are enabled.</i>

You can exit the sounder enabling mode also by pressing the “TEST/ SCROLL” button, as in that case the you reject the procedure.

8.2 “One man” Zone Testing

The “One Man” Test mode gives the installer the possibility to test the efficiency of the system - whether the detectors react to smoke, heat, etc.

☞ To do “One Man” Test of a zone:

• Press TEST/ SCROLL:	<i>µP Fault and General Fault LEDs light off. All other system indication LEDs light on permanently.</i>
• Press TEST/ SCROLL again:	<i>The TEST LED and ZONE 1 yellow LED start blinking. ZONE 1 is in test mode. Test a detector from this zone whether it react to smoke, heat, etc.</i>
• Press TEST/ SCROLL again to continue with the system testing:	<i>TEST LED will continue blinking. The ZONE 1 yellow LED lights out (the zone is not longer in test mode). The ZONE 2 yellow LED blinks in yellow. ZONE 2 is in test mode. Test a detector from this zone whether it react to smoke, heat, etc.</i>

Continue the system testing by pressing the “TEST/ SCROLL” button. The exit from the “One Man” Test mode is automatic after the end of the test procedure in the last Zone 4, or at any time by pressing “RESET” button.

9. Technical Specifications of ERACLE 2/4

Zones:

- ERACLE 2 - 2 fixed zones
- ERACLE 4 - 4 fixed zones

Maximum number of detectors per zone:

- Up to 20 (or 32 ERACLE series detectors: 43RCS001, 43RCS000, 43RFU000, 43RML000) conventional detectors and unlimited number of manual call points.

Thresholds for zone conditions:

- $0 \div 2$ mA - Open circuit fault condition
- $2 \div 10$ mA - Normal condition
- $10 \div 110$ mA - Fire Alarm condition
- 110 mA - Short circuit condition

Power Supply:

- Main Power supply: 230V AC $\pm 10\%$; 0.315A fuse
- Standby Power supply: 1 x 12V / 7Ah; 2A fuse
- Internal resistance of accumulator battery: $R_i < 1.6\Omega$

Maximum current available for system devices (with fully charged battery):

- 0.7 A

Current consumption - mains failure:

- 50 mA

Outputs:

- Sounder Circuit 1: 24V / 0.3A; 0.3A fuse (PTC)
- Sounder Circuit 2: 24V / 0.3A; 0.3A fuse (PTC)
- Fault Relay, volt free changeover contacts*: 3A @ 120V AC; 3A @ 60V DC
- Fire Relay, volt free changeover contacts*: 3A @ 120V AC; 3A @ 60V DC

* **Note:** These functions may not be used to provide any "Options with requirements" as specified in EN 54-2.

Auxiliary output:

- 24V DC, 0.3A fuse (PTC)

Cabling:

- Maximum 2.5mm diameter

Environment:

- Working temperature: -5 to 40°C
- Storage temperature: -20 to 60°C
- Humidity: 0 to 95%

Temperature sensor:

The temperature sensor is used for measurement of the battery temperature. The sensor is mounted at the end of the wired fly lead, factory connected to "Temperature sensor" terminal on the panel's PCB.

The temperature sensor should be placed behind or under the battery.

10. Connection Diagrams ERACLE 2/4

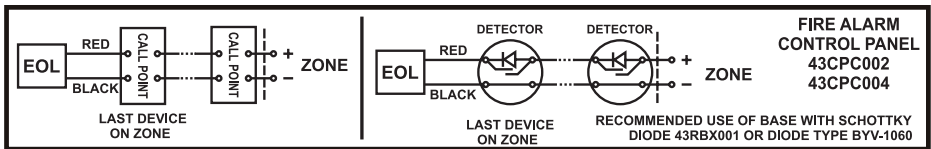
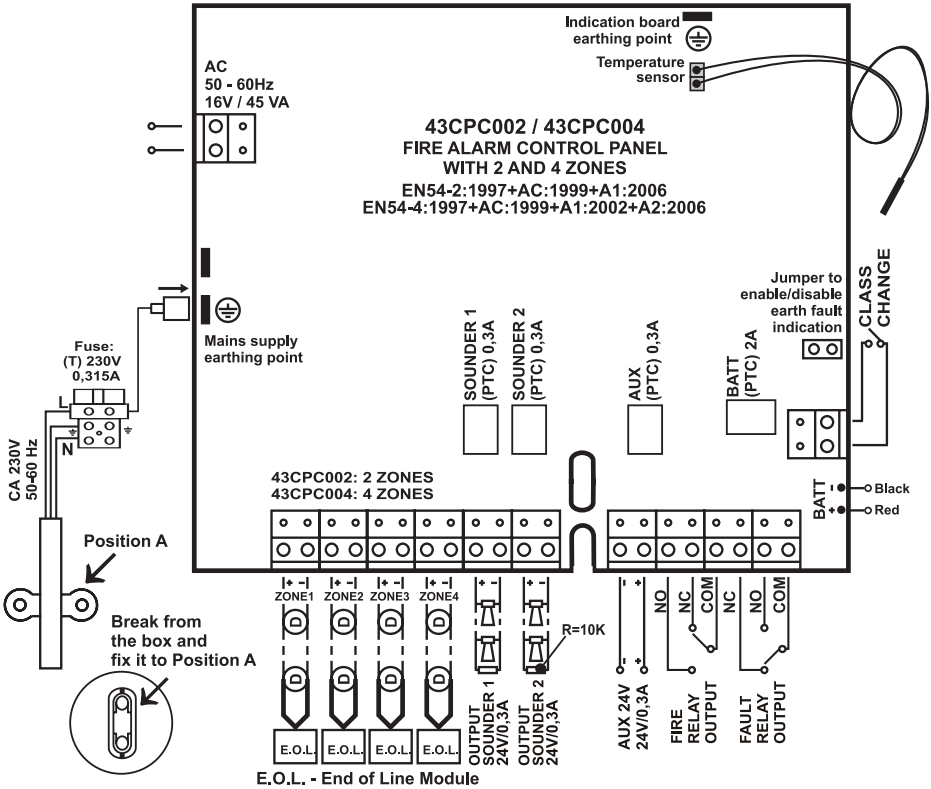

11. Fire Alarm Record

Installation Address:

.....

.....

.....

Contact Person:

.....

Telephone:

.....

Fax:

.....

Date Completed:

.....

Commissioned By:

.....

Contract Reference:

.....

Service Intervals: Monthly / Quarterly / Half Yearly / Annually

ZONE No	LOCATION	DETECTOR TYPE and QUANTITY PER ZONE					SOUNDERS (Zone Quantity and Related Circuit)	
		Ion*	Ph	RoR	F/T	CP	Circuit1	Circuit2
1								
2								
3								
4								
	TOTALS:							

* Ion - Ionisation sensor, Ph - Photoelectric sensor, RoR - Rate of Rise sensor, F/T - Fixed Temperature sensor, CP - Call Point

System Installed By:

Telephone / Fax:







12. Service Record

Date Visit Completed	Zones Tested	Faults Rectified	Signature of Engineer	Next Due
	1 2 3 4		Name:	
	1 2 3 4		Name:	
	1 2 3 4		Name:	
	1 2 3 4		Name:	

13. Fire Alarm Event LOG

DATE	TIME	FIRE yes / no	ZONE number	FAULT yes/no and TYPE	ACTION TAKEN	Name

14. Spare Part Kits

ERACLE 2/ ERACLE 4			
No	Component	Description	Q-ty
1		Fuse 0.315A, 5x20	1
2		Key, 10mm	2
3		Self-tapping screw, 2.9x13 mm, DIN7981	2
4		Plastic cap, 20mm	4
5		Resistor 10K ±1%, 0.25W	3
6		EOL Module	3/5

Comelit Group S.p.A.

Via Don Arrigoni 5 - 24020 Rovetta S. Lorenzo BG Italy

tel. +39 0346 750 011; fax +39 0346 71436

www.comelitgroup.com - info@comelit.it

